

MB FRIGO

MODULAR COLD ROOMS



**CHILLING
YOUR WORLD**
SINCE 1981

ARCTIC CELL



Our team of experts supports you from idea to implementation.

TOP QUALITY



Our products are of the highest quality – from the individual components to the finished product.

EXPERTISE



We improve our know-how and skills on a daily basis, positively impacting every business and production segment.

INVESTING IN THE FUTURE



Our products are continuously optimized to achieve the best possible energy efficiency. Our clients want to invest in the future and are already thinking about how they can reduce future maintenance costs.

ENGINEERING-INSTALLER APPROACH



We combine an innovative engineering approach with installation experience and technical support.

ADAPTABILITY



We design, construct and manufacture refrigeration equipment according to customer requirements.

By offering quality and recognizable products, innovative solutions and excellent service, we want to improve the quality of life and achieve business success of each user of our products and services.



MB FRIGO GRUPA

PRODUCTION OF REFRIGERATION EQUIPMENT

Years of Experience

For more than 40 years, we have been developing and improving our own in-house range of refrigeration products and equipment, which we deliver all across the globe. While we started out as a small family business, today we have a team of over 180 employees. Together with our sister companies across the Adriatic region, we comprise the current MB Frigo Group.

Product Range and Flexibility

We specialise in the manufacture of cold rooms, refrigeration doors, and refrigeration units. The high flexibility of our range of products facilitates custom-made manufacture and adjustment to specific customer requests.

Manufacturing Line Modernisation

Continuous investments into the professional development of our employees and the modernisation of our range of products guarantee the delivery of top-quality products in accordance with EU and ISO 9001 norms.

Environmental Awareness

In all our activities, we take care that we comply with all relevant legal and industry regulations as well as environmental standards. All company activities comply with ISO 14001: Environmental Management Systems.

ARCTIC CELL

modular cold rooms

We design and manufacture cold rooms tailored to specific customer requirements.



High-quality panel connections guarantee optimal energy efficiency.



Modularity enables full adjustment to available space.



Environmentally friendly products.



Use of food safe contact materials.



Compliant with EU norms.



Compliant with ISO norms.



Quick and easy assembly without power tools.



Low cost of ownership during entire life cycle. *1



No silicone.



High level of assembly readiness.



High packaging standards to protect and safely transport goods.



Recommended by refrigeration specialists.



Floors in a wide range of load-bearing capacities.



Innovative solutions and special requests.



High control of factory production and inspection of finished products.



Production according to customer requirements.

*1 Ownership cost includes all costs incurred during a product's life cycle (the product's purchase, installation, energy costs incurred through refrigeration equipment's use, maintenance and servicing costs, as well as eco-friendly disposal of the product after its discontinuation).



SQUARE COLD ROOM



L- COLD ROOM



COMBINED COLD ROOM



COLD ROOM WITH SPECIFIC ANGLES

TECHNICAL DATA

COLD ROOM WITH TOP-QUALITY JOINTS

- Insulation panel joints are designed as tongue-and-groove with integrated gaskets
- Panels are connected using eccentric cam locks with tensile strength of 500 kg, ensuring excellent insulation along the full length of a panel connection, eliminating the need for silicone
- the angles integrated in the panel ensure a minimum number of joints and thus reduce energy losses

ECO-FRIENDLY THERMAL INSULATION CORE

- Panel core made of polyurethane foam with a density of 40-42 kg/m³
- In accordance with F-Gas regulations, ecological GWP / ODP superior HFO technology is used as an expansion agent in polyurethane foam

HIGH-TECH GALVANISED STEEL SHEET

- High-tech composite steel sheet DX51D-ZM120, thickness of 0.5 mm, colour RAL 9010 was used
- The base consists of hot-rolled steel, of excellent mechanical properties, treated by the process of residual stresses normalizing
- Pre-treatment with zinc-magnesium, with 120g / m² coating provides corrosion protection according to the highest standards
- Protective transparent foil, thickness of 120 µm ensures protection of the metal sheet surface during transport and installation
- Additional coating on the inside of the 10 µm panel ensures better adhesion of polyurethane foam and sheet metal

STAINLESS STEEL METAL

- 0.6 mm thick AISI304 or AISI 316 stainless steel panel version is available
- Surface treatment by Scotch Brite or circular sanding

FOOD CONTACT SAFETY

- Steel sheet surface does not contain any substances that would affect the product (in compliance with the food industry regulation EN 11886-5*1)

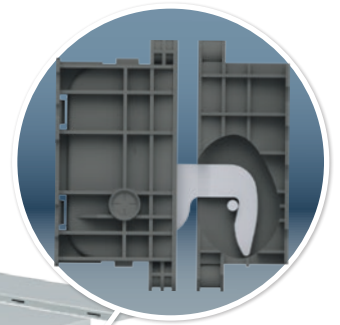

500 KG
TENSILE
STRENGTH
CAM LOCKS
PERFECT
JOINT



TECHNICAL DATA	
Operating temperature range (+/-) *2	-40°C to +70°C
Reaction to fire	C s3 d0 (System 1) *3
Panel thickness for positive and/ or negative operating temperature range	80 mm 100 mm 120 mm 160 mm
Standard internal height	2200 mm 2400 mm 2600 mm 2800 mm
Special internal height	up to max. 4000 mm
Standard expansion (increments)	±280 mm
Special expansion (increments)	±40 mm
Angle expansion	expansion of standard 90° angle is possible in 5° increments (e.g. 95°, 100°...)

*1 - ISO 11886-5, per which the following tests are conducted:
 1. Overall extract migration with distilled water in migration cell.
 2. Overall extract migration with 3% acetic acid in migration cell.
 *2 - Operating temperature range refers to refrigeration panels
 *3 - In compliance with EN 13501

COLD ROOM U-VALUE (heat transfer coefficient as defined in EN 14509)	
mm	W / (m ² K)
ISO 80	0,26
ISO 100	0,20
ISO 120	0,17
ISO 160	0,13

INSULATION LAMBDA VALUE
λ = 0.0225 W/mK
The lambda value is calculated according to a strictly defined method - measuring at +10°C, and include the ageing effect, which is strictly defined in EN 13165.

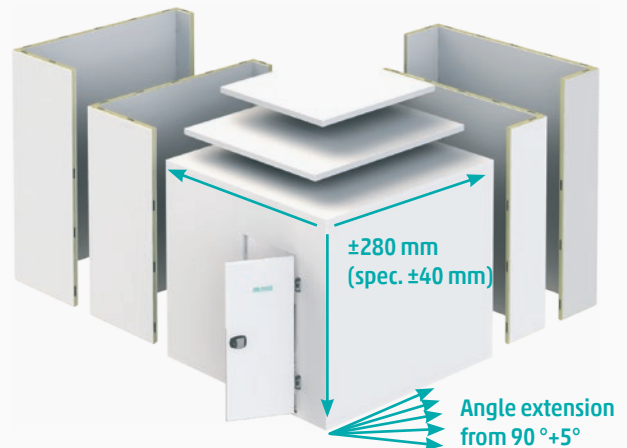

Video - quick and easy assembly without power tools



Video - ArctiCell cold rooms



Download declaration of performance (DOP)



Download technical data sheet (TDS)

TECHNICAL DATA

refrigeration doors

ARTICELL REFRIGERATION HINGED DOORS

- refrigerator doors are constructed with a minimum number of joints and without thermal bridges, to ensure superior insulation properties and better energy efficiency
 - the door's sheet metal and insulation are of the same quality as the ArtiCell refrigeration panels
- FACTORY PRODUCTION CONTROL**
- manufacturing quality is constantly examined, supervised, evaluated, and assessed to facilitate consistently high quality. Verifiable via Initial Type Test (ITT) and Factory Production Control (FPC) certificates issued by the notified body (NB).



HINGES

- doors are equipped with hinges made from a quality composite that is resistant to temperature fluctuations
- door leaf is lifted and lowered on the hinges to ensure optimal sealing and a long life span of the floor seal
- all hinges are adjustable on all three axes, ensuring precise centring of the door
 - up/ down
 - left/ right
 - forwards/ backwards

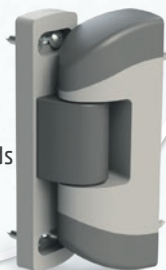

LOCK

- the doors are equipped with locks made from a high-quality composite, with a lock cylinder

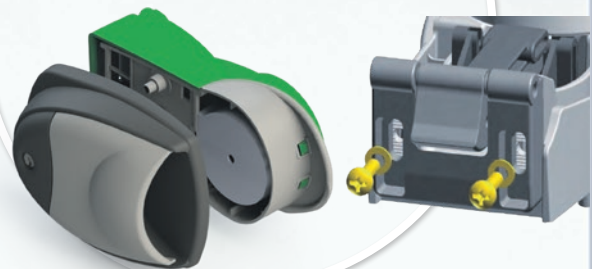

SAFETY

- the doors are equipped with a fluorescently labelled "ANTIPANIC" mechanism to open the door from the inside
- opening doors and exiting is possible even if doors are locked from the outside, which is in accordance with EN 179



SEALS

- the seal preserves its elasticity and quality for a long period of time and in different operating temperature ranges

HEATER FOR NEGATIVE OPERATING TEMPERATURE

- doors for negative operating temperature ranges are equipped with an electric heater standardly

REFRIGERATION DOORS	STANDARD DIMENSIONS							
WIDTH (mm)	800	900	1000	1200				
HEIGHT (mm)	2000	2200	2000	2200	2000	2200	2000	2200



Video - door adjustment

TECHNICAL DATA

refrigeration floor

COLD ROOM FLOORS – MAXIMUM INSULATION & LOAD CAPACITY

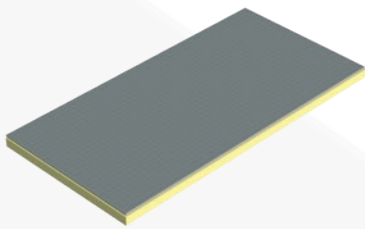

BASIC FLOOR R9/90

Material:

- hot-dip galvanised steel (DX51D-ZM120), covered with embossed PVC
- anti-slip design R9

Permissible load:

- static, even load up to 3000 kg/m²
- dynamic, concentrated load up to 90 kg/4 cm²

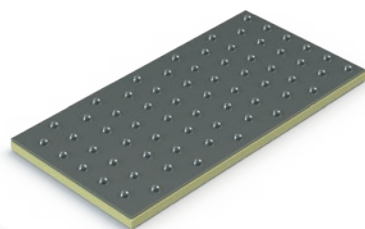

FLOOR LD 90

Material:

- stainless steel (AISI 304) Scotch Brite finish
- anti-slip design with conically embossed pattern

Permissible load:

- static, even load up to 3000 kg/m²
- dynamic, concentrated load up to 90 kg/4 cm²

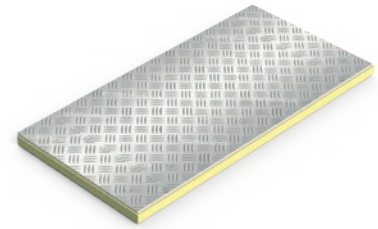

FLOOR R11/120

Material:

- stainless steel (AISI 304) Scotch Brite finish
- anti-slip design with class SE-TB1-R11 pattern

Permissible load:

- static, even load up to 3000 kg/m²
- dynamic, concentrated load up to 120 kg/4 cm²

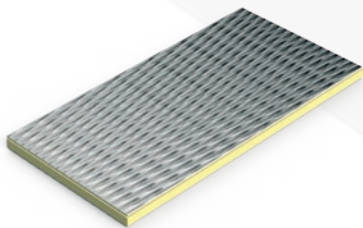

FLOOR R12/300

Material:

- stainless steel (AISI 304) Scotch Brite finish
- anti-slip design with class SE-5WL-R12 pattern

Permissible load:

- static, even load up to 4000 kg/m²
- dynamic, concentrated load up to 300 kg/4 cm²

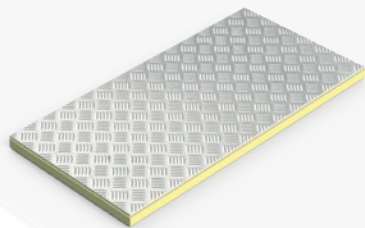

FLOOR HD 400

Material:

- ribbed aluminium sheet steel (AlMg3)
- anti-slip design with ribbed tear-drop pattern

Permissible load:

- static, even load up to 4000 kg/m²
- dynamic, concentrated load up to 400 kg/8 cm²

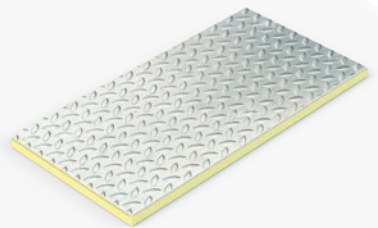

FLOOR HD 650

Material:

- hot-dip galvanised steel (S235), floating design
- anti-slip design

Permissible load:

- static, even load up to 5000 kg/m²
- dynamic, concentrated load up to 650 kg/8 cm²

ADDITIONAL EQUIPMENT

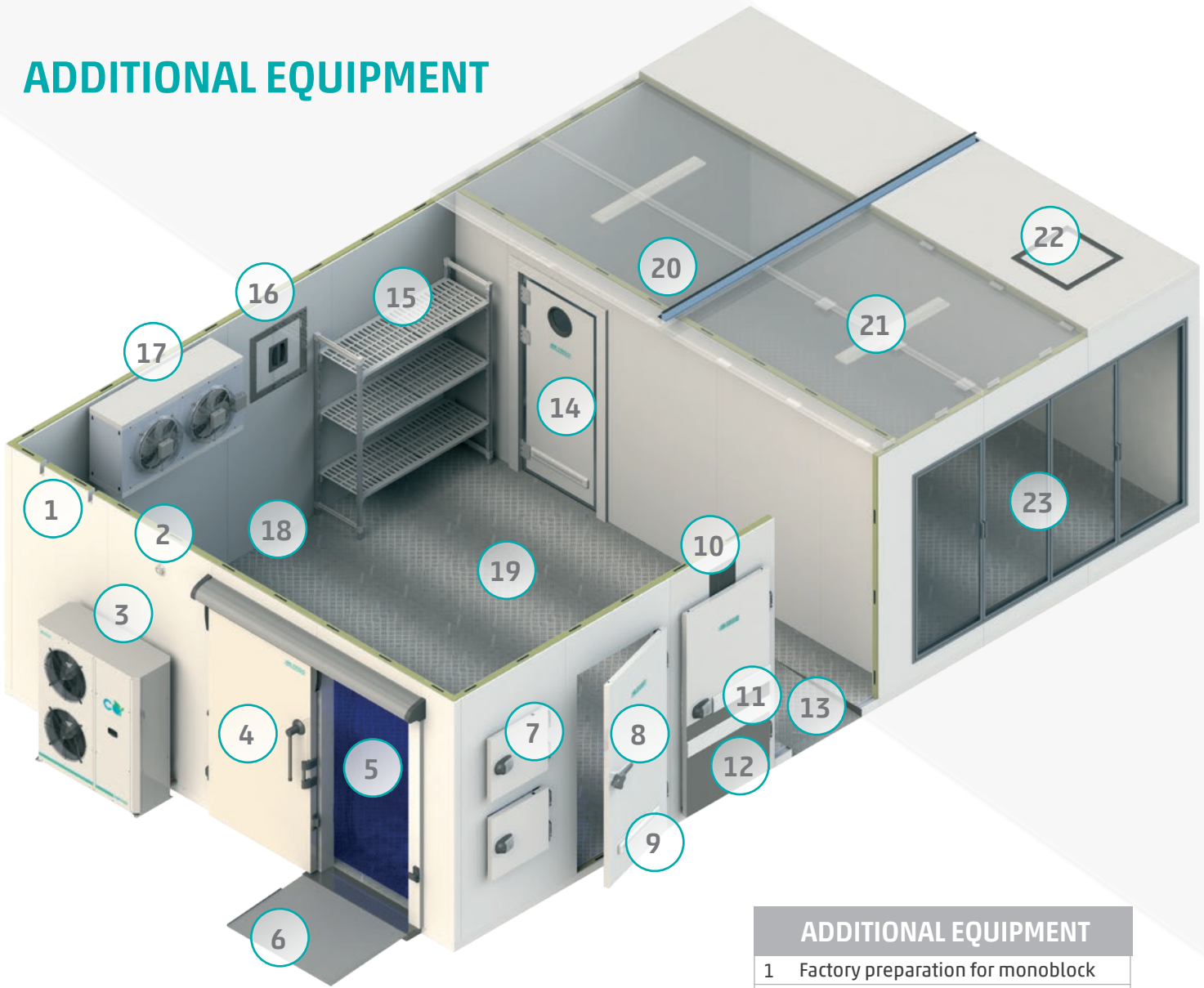

ADDITIONAL EQUIPMENT

1	Factory preparation for monoblock
2	Compensation valve
3	Cooling unit ArctiCo2
4	Built-in sliding door
5	Strip curtain
6	External ramp
7	Refrigeration doors with special dimension
8	STUV locking system
9	Bumper
10	Guideway passage
11	Acrylic bumper
12	Door with circle-brushed covering
13	Internal ramp
14	Push&pull door with bumper and inspection window
15	Shelves
16	Wall-mounted hatch
17	Evaporator
18	Sanitary profiles
19	Floor R11/120
20	T-suspension
21	Lighting
22	Ceiling-mounted hatch
23	Glass door

STANDARD COLD ROOM DIMENSIONS

PANEL THICKNESS: 80 mm

		LENGHT (mm)																
IZO 80		1560	1840	2120	2400	2680	2960	3240	3520	3800	4080	4360	4640	4920	5200	5480	5760	6040
WIDTH (mm)	1560	█																
	1840	█	█															
	2120	█	█	█														
	2400	█	█	█	█													
	2680	█	█	█	█	█												
	2960	█	█	█	█	█	█											
	3240	█	█	█	█	█	█	█										
	3520	█	█	█	█	█	█	█	█									
	3800	█	█	█	█	█	█	█	█	█								
	4080	█	█	█	█	█	█	█	█	█	█							
	4360	█	█	█	█	█	█	█	█	█	█	█						
	4640	█	█	█	█	█	█	█	█	█	█	█	█					
	4920	█	█	█	█	█	█	█	█	█	█	█	█	█				
	5200	█	█	█	█	█	█	█	█	█	█	█	█	█	█			
	5480	█	█	█	█	█	█	█	█	█	█	█	█	█	█	█		
	5760	█	█	█	█	█	█	█	█	█	█	█	█	█	█	█	█	
6040	█	█	█	█	█	█	█	█	█	█	█	█	█	█	█	█	█	

Standard internal heights (mm): 2200 | 2400 | 2600 | 2800

PANEL THICKNESS: 100 mm

		LENGHT (mm)																
IZO 100		1600	1880	2160	2440	2720	3000	3280	3560	3840	4120	4400	4680	4960	5240	5520	5800	6080
WIDTH (mm)	1600	█																
	1880	█	█															
	2160	█	█	█														
	2440	█	█	█	█													
	2720	█	█	█	█	█												
	3000	█	█	█	█	█	█											
	3280	█	█	█	█	█	█	█										
	3560	█	█	█	█	█	█	█	█									
	3840	█	█	█	█	█	█	█	█	█								
	4120	█	█	█	█	█	█	█	█	█	█							
	4400	█	█	█	█	█	█	█	█	█	█	█						
	4680	█	█	█	█	█	█	█	█	█	█	█	█					
	4960	█	█	█	█	█	█	█	█	█	█	█	█	█				
	5240	█	█	█	█	█	█	█	█	█	█	█	█	█	█			
	5520	█	█	█	█	█	█	█	█	█	█	█	█	█	█	█		
	5800	█	█	█	█	█	█	█	█	█	█	█	█	█	█	█	█	
6080	█	█	█	█	█	█	█	█	█	█	█	█	█	█	█	█	█	

Standard internal heights (mm): 2200 | 2400 | 2600 | 2800

PANEL THICKNESS: 120 mm

		LENGHT (mm)																
IZO 120		1640	1920	2200	2480	2760	3040	3320	3600	3880	4160	4440	4720	5000	5280	5560	5840	6120
WIDTH (mm)	1640	█																
	1920	█	█															
	2200	█	█	█														
	2480	█	█	█	█													
	2760	█	█	█	█	█												
	3040	█	█	█	█	█	█											
	3320	█	█	█	█	█	█	█										
	3600	█	█	█	█	█	█	█	█									
	3880	█	█	█	█	█	█	█	█	█								
	4160	█	█	█	█	█	█	█	█	█	█							
	4440	█	█	█	█	█	█	█	█	█	█	█						
	4720	█	█	█	█	█	█	█	█	█	█	█	█					
	5000	█	█	█	█	█	█	█	█	█	█	█	█	█				
	5280	█	█	█	█	█	█	█	█	█	█	█	█	█	█			
	5560	█	█	█	█	█	█	█	█	█	█	█	█	█	█	█		
	5840	█	█	█	█	█	█	█	█	█	█	█	█	█	█	█	█	
6120	█	█	█	█	█	█	█	█	█	█	█	█	█	█	█	█	█	

Standard internal heights (mm): 2200 | 2400 | 2600 | 2800

PANEL THICKNESS: 160 mm

		LENGHT (mm)																
IZO 160		1720	2000	2280	2560	2840	3120	3400	3680	3960	4240	4520	4800	5080	5360	5640	5920	6200
SİRINA (mm)	1720	█																
	2000	█	█															
	2280	█	█	█														
	2560	█	█	█	█													
	2840	█	█	█	█	█												
	3120	█	█	█	█	█	█											
	3400	█	█	█	█	█	█	█										
	3680	█	█	█	█	█	█	█	█									
	3960	█	█	█	█	█	█	█	█	█								
	4240	█	█	█	█	█	█	█	█	█	█							
	4520	█	█	█	█	█	█	█	█	█	█	█						
	4800	█	█	█	█	█	█	█	█	█	█	█	█					
	5080	█	█	█	█	█	█	█	█	█	█	█	█	█				
	5360	█	█	█	█	█	█	█	█	█	█	█	█	█	█			
	5640	█	█	█	█	█	█	█	█	█	█	█	█	█	█	█		
	5920	█	█	█	█	█	█	█	█	█	█	█	█	█	█	█	█	
6200	█	█	█	█	█	█	█	█	█	█	█	█	█	█	█	█	█	

Standard internal heights (mm): 2200 | 2400 | 2600 | 2800



MB FRIGO CHILLING
YOUR WORLD
SINCE 1981



Bani 81, 10010 Zagreb, Croatia
Tel: +385 1 660 8002, Fax: +385 1 660 9005
www.mbfrigo.com

Scan to download vCard

